



## **3 WALL SLIDING SHOWER TECHNICAL SPECIFICATIONS**



exclusive to  
**plumbing**world

[www.brenner.co.nz](http://www.brenner.co.nz)

# TYPICAL BASE PROFILE

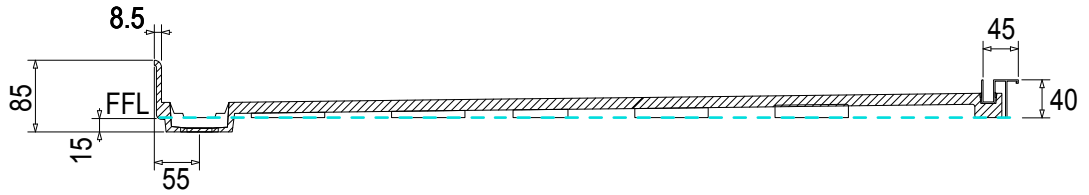

# WASTE DETAIL

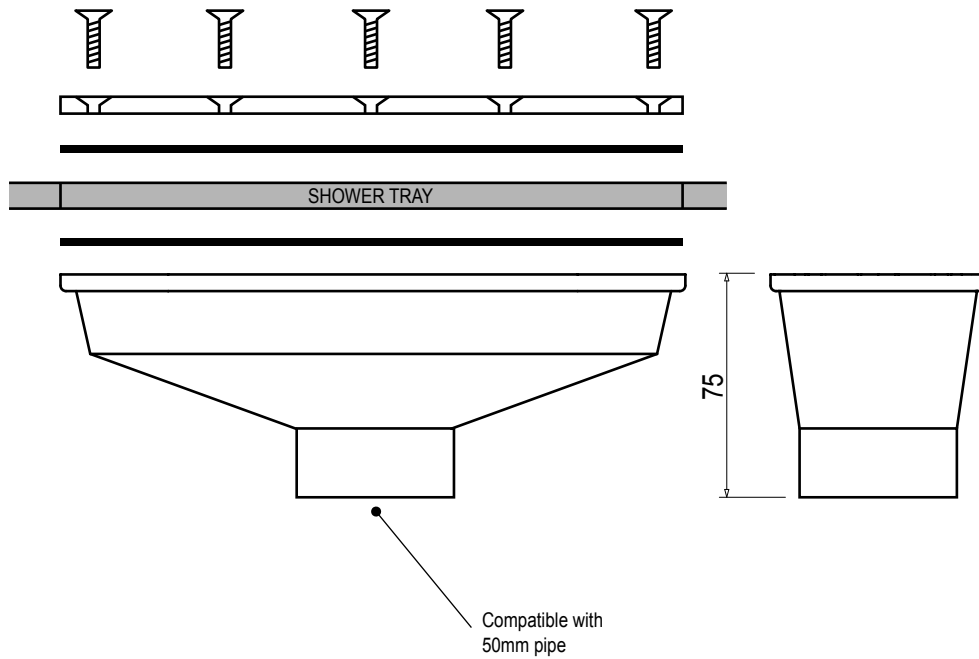

# WASTE RECESS

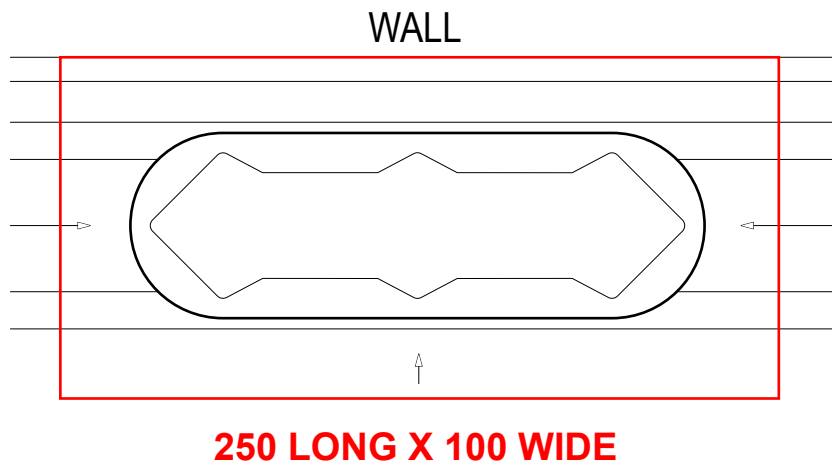

# REAR DRAIN

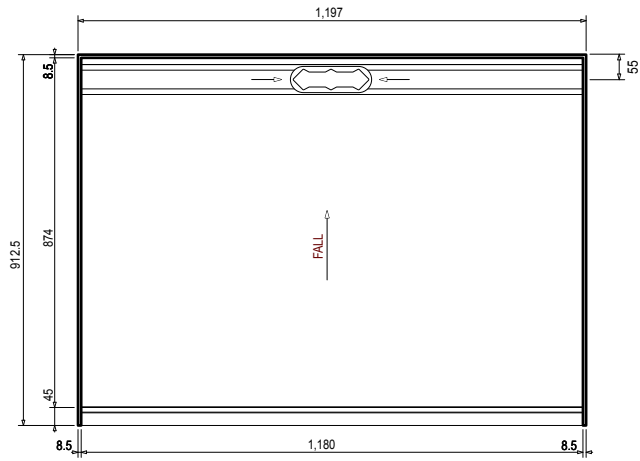

## SLIDING SCREENS CONFIGURATION

Please see *Hinged Specifications* for information on Hinged Screens.

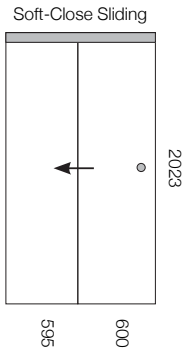

Screens are reversible

# REAR DRAIN

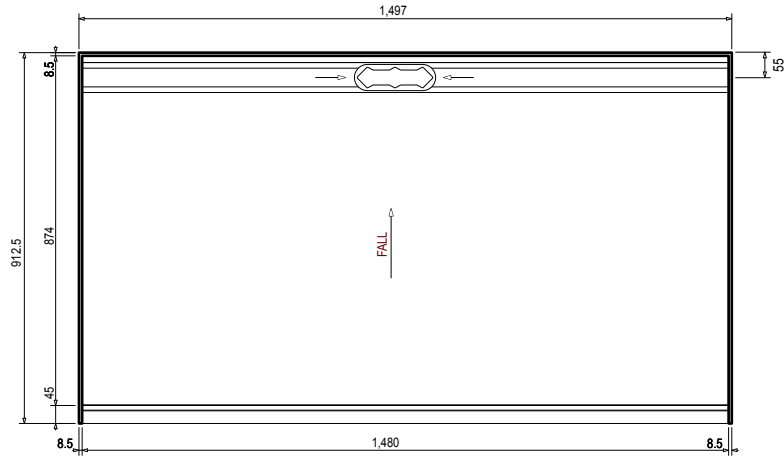

## SLIDING SCREENS CONFIGURATION

Please see *Hinged Specifications* for information on Hinged Screens.

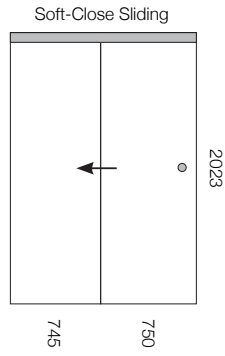

Screens are reversible

# REAR DRAIN

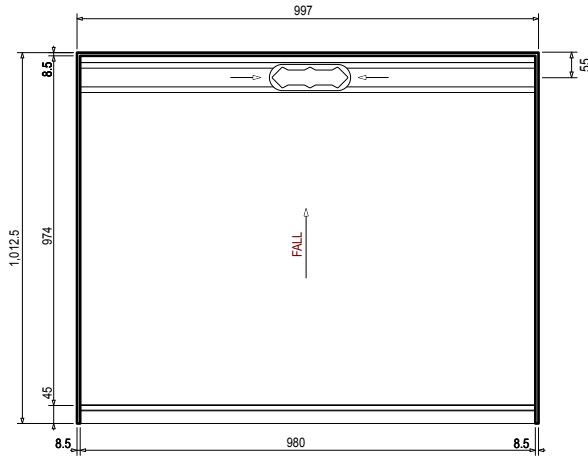

## SLIDING SCREENS CONFIGURATION

Please see *Hinged Specifications* for information on Hinged Screens.

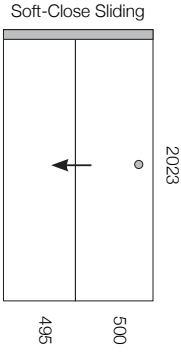

Screens are reversible

# REAR DRAIN

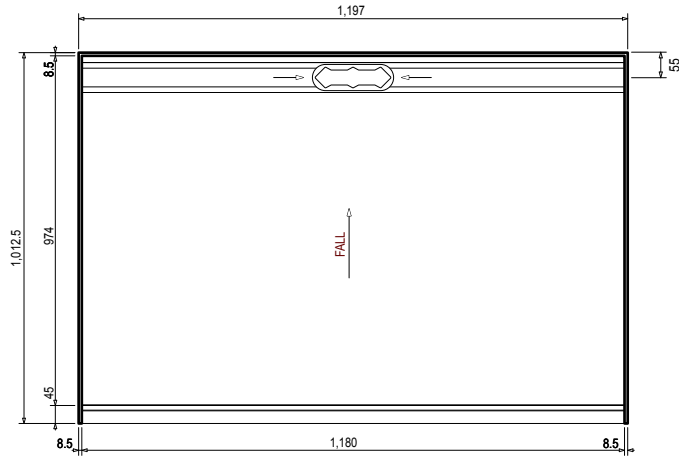

## SLIDING SCREENS CONFIGURATION

Please see *Hinged Specifications* for information on Hinged Screens.

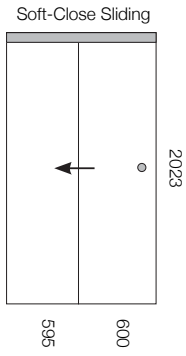

Screens are reversible

# REAR DRAIN

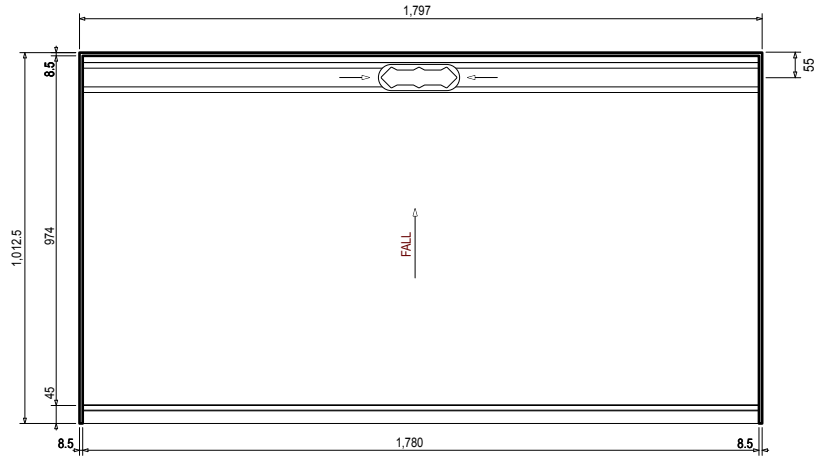

## SLIDING SCREENS CONFIGURATION

Please see *Hinged Specifications* for information on Hinged Screens.

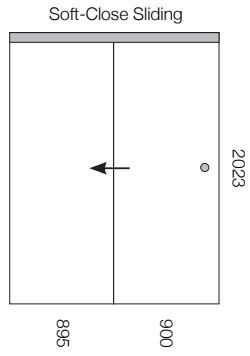

Screens are reversible