



HINGING SCREEN FITTING INSTRUCTIONS – HR

Components:

- | | |
|---------------------------------|--------------------------|
| 1 x Bag 1 – Allen Keys | <input type="checkbox"/> |
| 1 x Bag 11 - Packers | <input type="checkbox"/> |
| 1 x Clear Silicon | <input type="checkbox"/> |
| 1 x Handles Set E | <input type="checkbox"/> |
| 2 x Hinges adjustable – STD | <input type="checkbox"/> |
| 1 x Screen Fitting Instructions | <input type="checkbox"/> |
| 1 x Blue Masking Tape | <input type="checkbox"/> |

Checked by: _____

Date: _____

Other equipment required:

- Caulking Gun
- Drill
- Level
- Pencil
- Tape Measure
- Knife

Included in this package:

- | | | | | | | | | | | | | | | | | | | | |
|---|--|--------------------------|---------------------------------|--------------------------|---|--------------------------|---|--------------------------|--|--|--------------------------|---|--|---|--------------------------|---------------|--------------------------|----------------------------------|--------------------------|
| <table border="0"> <tr> <td>1 x Glass Door with 2 Cutouts A</td> <td><input type="checkbox"/></td> </tr> <tr> <td>1 x Glass Return Panel B</td> <td><input type="checkbox"/></td> </tr> <tr> <td>1 x Fixed Panel with 2 Cutouts C</td> <td><input type="checkbox"/></td> </tr> <tr> <td>1 x Metal Top Brace - AU-MTB (not plied on 3 wall showers 1000mm or less)</td> <td><input type="checkbox"/></td> </tr> </table> | 1 x Glass Door with 2 Cutouts A | <input type="checkbox"/> | 1 x Glass Return Panel B | <input type="checkbox"/> | 1 x Fixed Panel with 2 Cutouts C | <input type="checkbox"/> | 1 x Metal Top Brace - AU-MTB (not plied on 3 wall showers 1000mm or less) | <input type="checkbox"/> | <table border="0"> <tr> <td>2 x Glass Receiver Channels – WCT</td> <td><input type="checkbox"/></td> </tr> <tr> <td>Below components included in WCT</td> <td></td> </tr> <tr> <td>1 x 8x6Gx40 Sq drive screws & wall plugs – 1x4mm drill bit</td> <td><input type="checkbox"/></td> </tr> <tr> <td>2 x Edge Seal</td> <td><input type="checkbox"/></td> </tr> <tr> <td>1 x Clear Bottom Seal - Standard</td> <td><input type="checkbox"/></td> </tr> </table> | 2 x Glass Receiver Channels – WCT | <input type="checkbox"/> | Below components included in WCT | | 1 x 8x6Gx40 Sq drive screws & wall plugs – 1x4mm drill bit | <input type="checkbox"/> | 2 x Edge Seal | <input type="checkbox"/> | 1 x Clear Bottom Seal - Standard | <input type="checkbox"/> |
| 1 x Glass Door with 2 Cutouts A | <input type="checkbox"/> | | | | | | | | | | | | | | | | | | |
| 1 x Glass Return Panel B | <input type="checkbox"/> | | | | | | | | | | | | | | | | | | |
| 1 x Fixed Panel with 2 Cutouts C | <input type="checkbox"/> | | | | | | | | | | | | | | | | | | |
| 1 x Metal Top Brace - AU-MTB (not plied on 3 wall showers 1000mm or less) | <input type="checkbox"/> | | | | | | | | | | | | | | | | | | |
| 2 x Glass Receiver Channels – WCT | <input type="checkbox"/> | | | | | | | | | | | | | | | | | | |
| Below components included in WCT | | | | | | | | | | | | | | | | | | | |
| 1 x 8x6Gx40 Sq drive screws & wall plugs – 1x4mm drill bit | <input type="checkbox"/> | | | | | | | | | | | | | | | | | | |
| 2 x Edge Seal | <input type="checkbox"/> | | | | | | | | | | | | | | | | | | |
| 1 x Clear Bottom Seal - Standard | <input type="checkbox"/> | | | | | | | | | | | | | | | | | | |

*TO MAKE SURE THAT YOU HAVE THE MOST UP TO DATE INSTRUCTIONS, SCAN THE FOLLOWING **QR CODE**. THIS WILL LINK YOU TO THE LATEST INSTRUCTION FILE ON OUR WEBSITE:*



PLEASE NOTE: Stand glass upright at all times. Keep glass panels level with the floor to avoid damaging corners.

NO RESPONSIBILITY WILL BE TAKEN BY ATLANTIS FOR ANY GLASS BREAKAGES OR CHIPPED EDGES.

DO NOT INSTALL DAMAGED OR DEFECTIVE PRODUCTS

- It is the installer's responsibility to thoroughly check the glass panel prior to installation.
- Atlantis will take no responsibility for any glass panel that has been installed with a noticeable defect.

NOTE: a noticeable defect must be visible to the naked eye, in normal daylight conditions, standing at a distance of two meters.

Any imperfection that is not visible within the above noted parameters will not be accepted by Atlantis to be a defective product, and installation can proceed as usual.

PLEASE NOTE: Stand glass upright at all times. Keep glass panels level with the floor to avoid damaging corners.

NO RESPONSIBILITY WILL BE TAKEN BY ATLANTIS FOR ANY GLASS BREAKAGES OR CHIPPED EDGE

WE RECOMMEND YOU DRY FIT ALL COMPONENTS FIRST TO ENSURE CORRECT FITMENT PRIOR TO SEALING IN PLACE.

INSTRUCTIONS FOR 2 WALL SYSTEM

GLASS RECEIVER CHANNEL MUST BE INSTALLED ONTO THE WATERPROOFING BEFORE THE WALLS ARE TILED



Installer – When Architectural Finish is fitted to base. Trim the internal leg off the wall channel to adequately clear the base surface. Ensure the wall channel interlocks correctly with the base.

1. Choose door location.

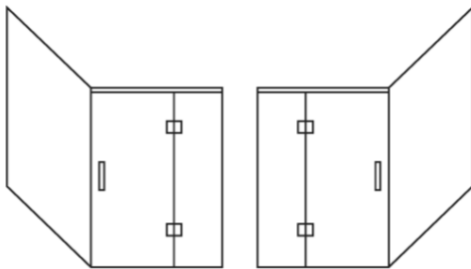

2. Position the glass receiver channels over the base glazing channels. Mark the wall to indicate where the wall channels are plumb.

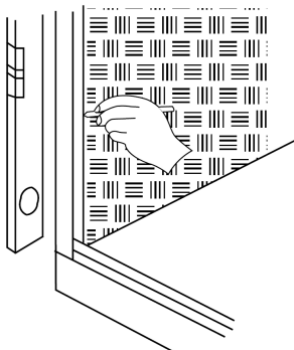

3. Apply white silicon to full length of channel.

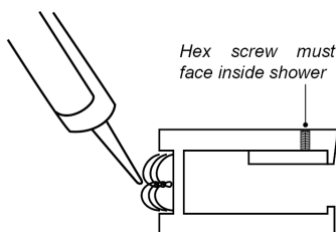

4. Ensure the glass receiver channels are located firmly over the base glazing channels. Locate the framing timber. Use the 4mm drill bit to drill holes through the glass receiver channels. Fix four screws through the channels into the wall framing (use wall plugs if required supplied with wall channels).

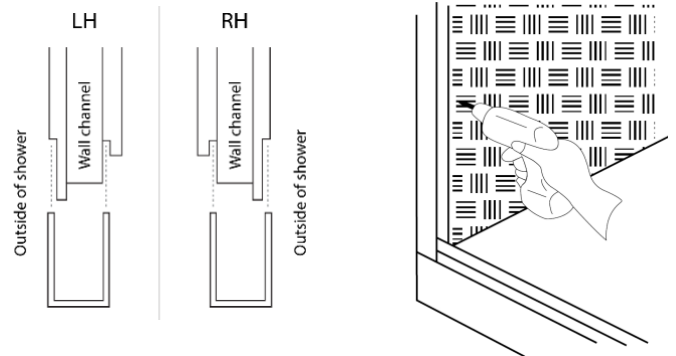

5. Apply a continuous bead of white silicon to the full length of the channels and waterproofing membrane, indicated by the dark line (inside channels).

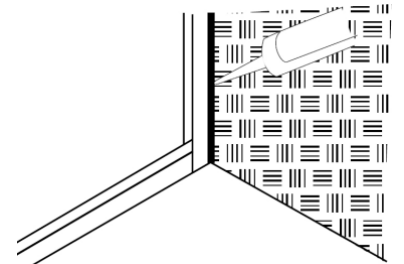

6. PREPARATION FOR GLASS INSTALLATION

Slide the sill infill into position and apply plastic packers (**BAG 11**) into the base glazing channels in locations as shown. Sill infill must measure 3mm larger than door, trim if required.

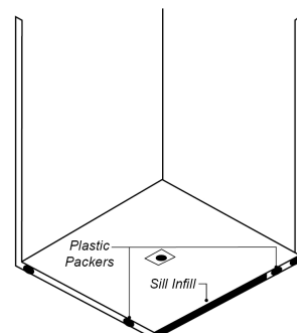

7. CRITICAL SEAL



Remove any dust and dirt first. Seal the connection between the glass receiver channel and the base glazing channel with clear silicon, prior to the installation of panel **B** and **C**.

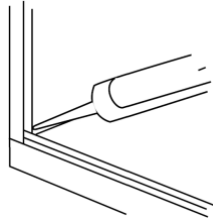

8. INSTALLATION OF RETURN PANEL

Locate panel **B** into the glazing channels. The top of panel **B** must be level with the top of the opposite glass receiver channel. Adjust the height of the panel if necessary by adding or removing the plastic packers in the base glazing channel.

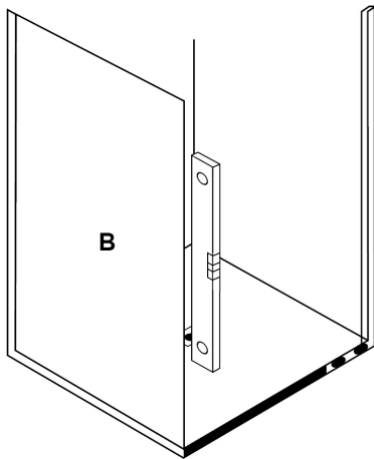

9. INSTALLATION OF FIXED PANEL

Locate panel **B** into the glazing channels. The top of panel **B** must be level with the top of panel **C**. Adjust the height of the panel if necessary by adding or removing the plastic packers in the base glazing channel.

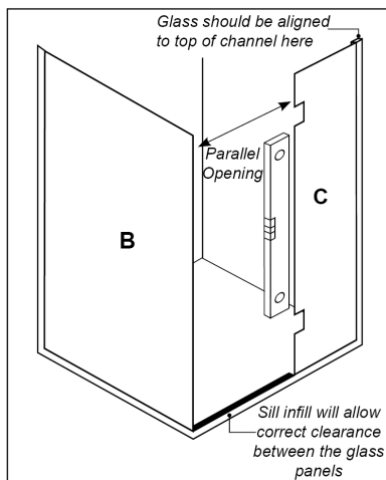

10. SILL INFILL

Apply a continuous bead of clear silicon to each inside face of the base channel. Ensure the ends of the infill are sealed and place into the base channel in the location as shown. Apply a generous quantity of silicone at either end of the sill infill prior to final glass placement.

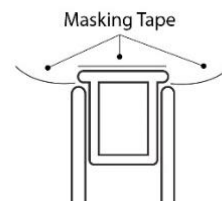
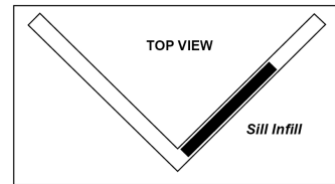

11. FASTENING GLASS

Secure the glass panels into the receiver channels by tightening hex key screws firmly with hex key supplied. **DO NOT OVERTIGHTEN.**

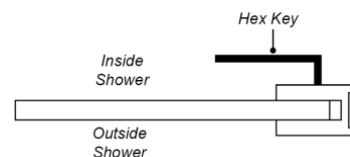

12. PROTECTION OF GLASS EDGE

Apply 1mm plastic packer to the edge of glass with the masking tape as shown. Position one next to each hinge cut out. **This will ensure correct door clearance and prevent glass damage.**

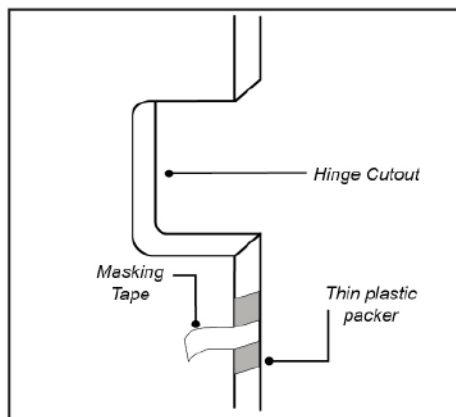

13. CLEARANCE UNDER DOOR

Place 6mm Spacers over the door infill before the installation of the glass door. This will give you enough clearance to have a door seal if required. See **Step 20** for more information.

14. HINGE INSTALLATION

Atlantis glass (EXCLUDING 1930MM HIGH GLASS) is now coated with CristalCote glass protection at the factory. This coating may cause the hinge to slip after installation. Atlantis recommends cleaning around the hinge cut out prior to fitting hinges. Clean both sides of the glass 15mm around the edge of the cut out with Fuelite (Fuelite is available from petrol stations). Alternatively, the area can be lightly sanded with 300grit sandpaper.

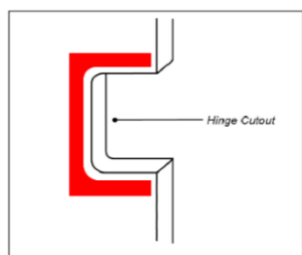

ADJUSTABLE HINGES

Atlantis showers are now supplied with adjustable hinges

COVER PLATE REMOVAL

Remove the cover plate by loosening the small grub screws on the edge of the hinge cover using a 1.5mm hex key. Loosen the bolts with 4mm hex key.

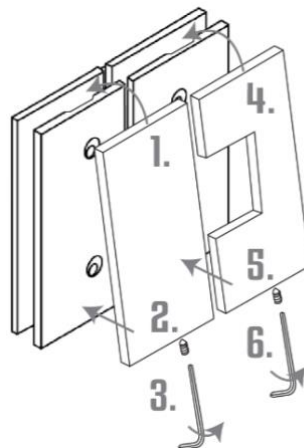

Fit the hinges. The removable cover (and bolts) must be on the outside of the shower. The reverse C holds the door and the other side goes onto the fixed panel

15. DOOR INSTALLATION

Hinges should be in the closed position (in line) before attempting to install the glass door.

Slide the door on to the hinges. Centre the door between the side panels and tighten the hinge bolts firmly with the 4mm hex key supplied.

ENSURE HINGES ARE CLEAR FROM SIDES OF GLASS CUTOUTS AND HINGE BOLTS ARE FINALLY TIGHTENED AS MUCH AS POSSIBLE.

VIEW FROM
INSIDE
SHOWER

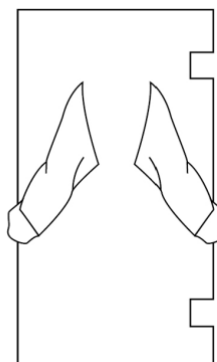

REFIT COVER PLATE

Place the cover plate over the hinge body as shown. Refit cover plate with a 1.5mm hex key.

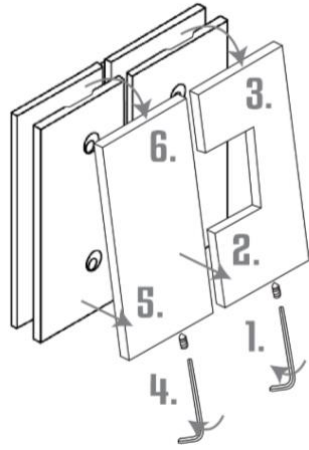

DOOR REALIGNMENT (if required)

Use 3mm key on the cap screws near the pivot to loosen the screws, align the door to desired position and then tighten.

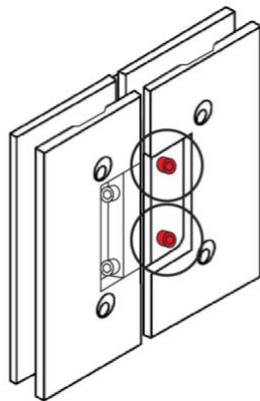

16. DOOR CLEARANCE

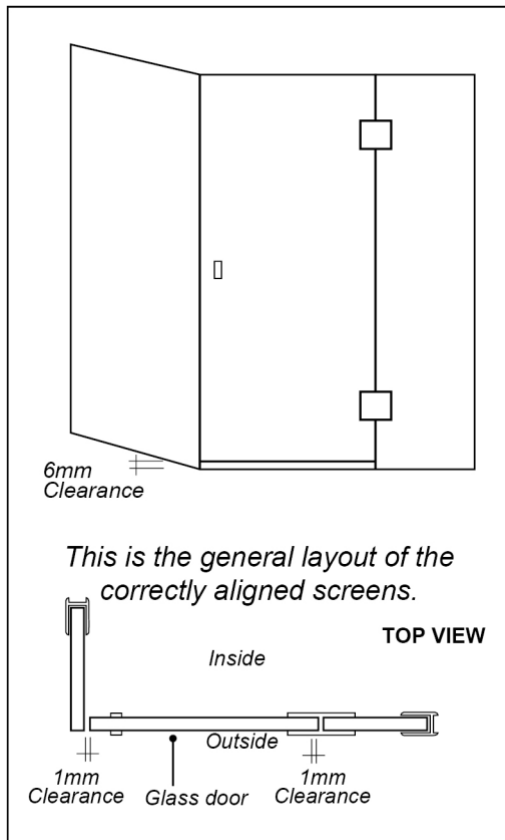

17. HANDLE INSTALLATION

Assemble the handles as shown.

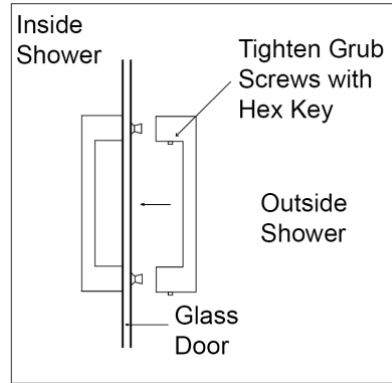

18. METAL TOP BRACE INSTALLATION

*Metal Top brace is **not** supplied on 3Wall showers 1000mm wide or less.*

Place the Top Brace onto the fixed glass panels in the position as shown. Lightly tighten grub screws. (**BAG-AU-MTB**) onto the glass panels.

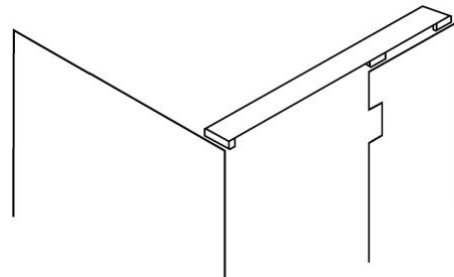

Lightly tighten the grub screws

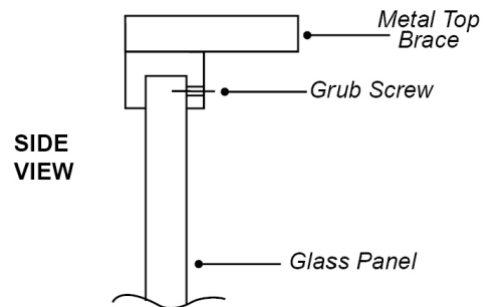

19. SILICON APPLICATION

Using the blue tape supplied, mask the glazing channels and glass at the intersections as shown. Apply clear silicon to the inside and outside of the glass panels. Remove the excess silicon. Remove the masking tape immediately after application.

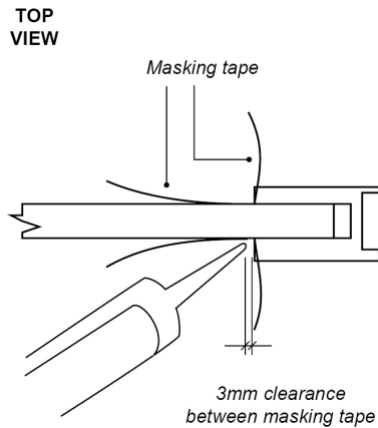

20. INSTALLATION OF BOTTOM DOOR SEAL

Trim to length if necessary. Clip onto the bottom of the door. Ensure the sloping face is inside the shower.

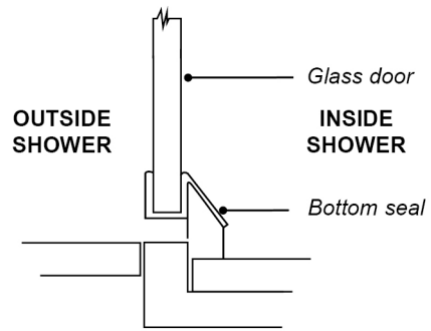

OPTIONAL DOOR SEALS

Two vertical edge seals are supplied with the wall glazing channels. These may be applied to the door opening edges (seals are usually applied to the fixed panels). Seals for the hinged side require being trimmed to fit between the hinges.

Should these seals be required, it is recommended to install them while installing the glass and hinges.

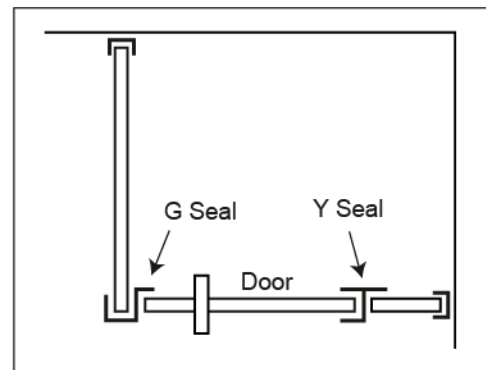

GLASS RECEIVER CHANNELS MUST BE INSTALLED ONTO THE WATERPROOFING BEFORE THE WALLS ARE TILED.

INSTRUCTIONS FOR 3 WALL SYSTEM



Installer – When Architectural Finish is fitted to base. Trim the internal leg off the wall channel to adequately clear the base surface. Ensure the wall channel interlocks correctly with the base.

1. Choose door direction.

Left or Right Hand

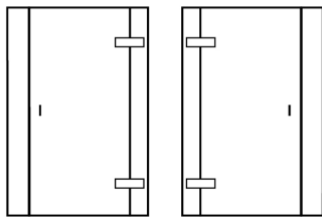

- 2.** Position the glass receiver channels over the base glazing channels. Use a straight edge and mark wall to indicate where the glass receiver channel is plumb.

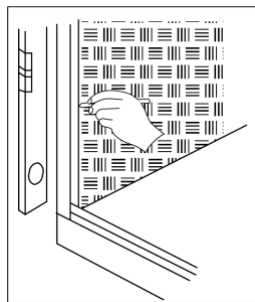

- 3.** Apply a silicon seal to full length of channel. Silicon used must be compatible with anodised aluminium as well as the waterproofing used.

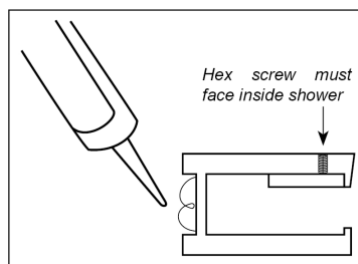

- 4.** Ensure the glass receiver channels are located firmly over the base glazing channels. The machine recess in the wall glazing channel must firmly locate over the base glazing channel.

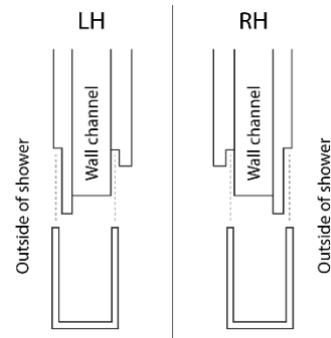

- 5.** Locate the framing timber. Use the 4mm drill bit to drill holes through the glass receiver channels. Fix four screws through the channels into the wall framing (use wall plugs if required).

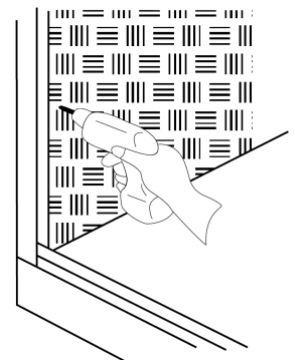

- 6.** Apply a continuous bead of silicon to the full length of the channel and waterproofing, indicated by the dark line (inside channel).

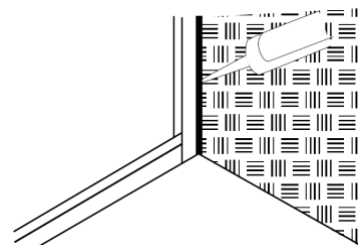

7. PREPARATION FOR GLASS INSTALLATION

Slide the sill infill into position to suit side glass panels. Apply plastic packers into the base glazing channels in locations as shown. Sill infill must measure 3mm larger than door, trim if required.

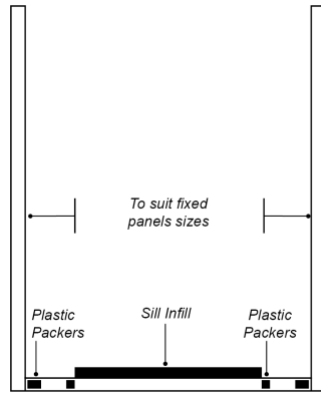

8. CRITICAL SEAL



Remove dust and dirt first. Seal the connection between the glass receiver channel and the base glazing channel with clear silicon (supplied), prior to the installation of panels **B** and **C**.

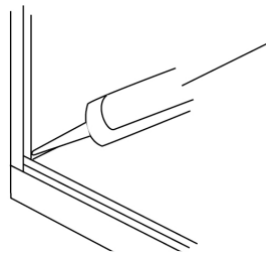

9. INSTALLATION OF RETURN PANEL

Locate the glass panels **B** and **C** into the glazing channels. The top of the panels should align to the top of the glass receiver channels. Add or remove packers in the base glazing channel as necessary for glass height alignment.

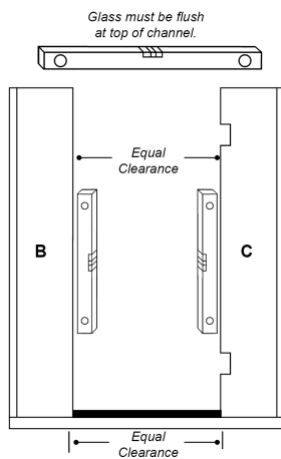

10. SILL INFILL

Apply a continuous bead of clear silicon to each inside face of the base channel. Ensure the ends of the infill are sealed

and place into the base channel in the location as shown.

TOP VIEW



11. FASTENING GLASS

Secure the glass panels into the receiver channels by tightening hex key screws firmly with hex key supplied. **DO NOT OVERTIGHTEN.**

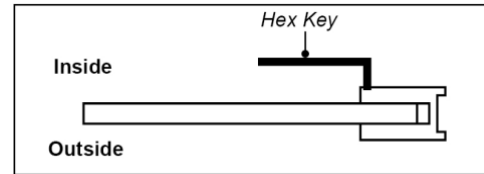

12. PROTECTION OF GLASS EDGE

Apply 1mm plastic packer to edge of glass with masking tape as shown. Position one next to each hinge cut out. **This will ensure correct door clearance and prevent glass damage).**

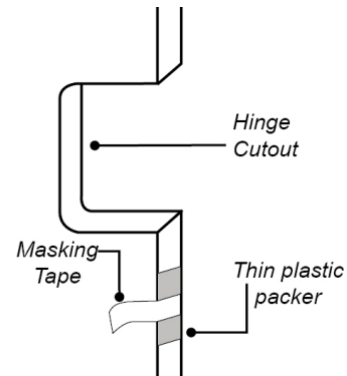

13. CLEARANCE UNDER DOOR

Place 6mm Spacers over the door infill before the installation of the glass door.

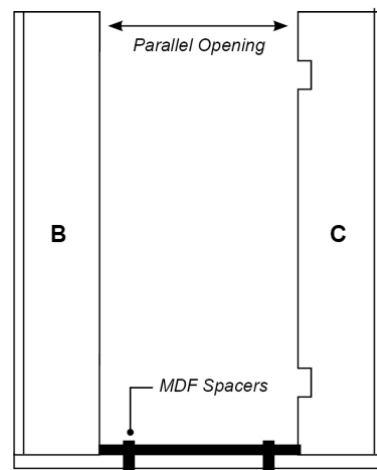

14. HINGE INSTALLATION

Atlantis glass (EXCLUDING 1930MM HIGH) is now coated with CristalCote glass protection at the factory. This coating may cause the hinge to slip after installation. Atlantis recommends cleaning around the hinge cut out prior to fitting hinges. Clean both sides of the glass 15mm around the edge of the cut out with Fuelite (fuellite is available from petrol stations). Alternatively, the area can be lightly sanded with 300grit sandpaper.

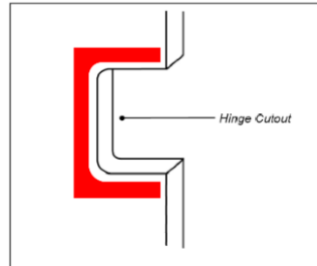

Slide the door into the hinges. Centre the door between the side panels and tighten the hinge bolts firmly with the 4mm hex key supplied.

ENSURE HINGES ARE CLEAR FROM SIDES OF GLASS CUTOUTS AND HINGE BOLTS ARE FINALLY TIGHTENED AS MUCH AS POSSIBLE.

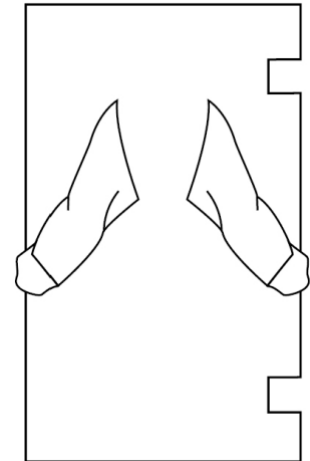

15. ADJUSTABLE HINGES

Atlantis showers are now supplied with adjustable hinges

COVER PLATE REMOVAL

Remove the cover plate with the small grub screw on the top of the hinge cover using 1.5mm key. Loosen the bolts with 4mm hex key.

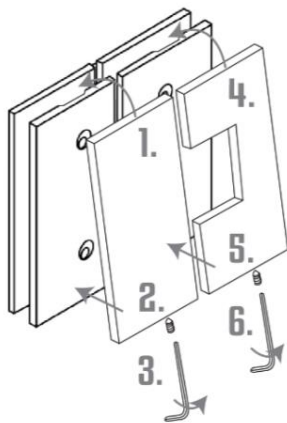

REFIT COVER PLATE

Ensure bolt heads are on the outside of the shower. Fit to glass and tighten until you hear a squeaking sound. Refit cover plate with 1.5mm hex key.

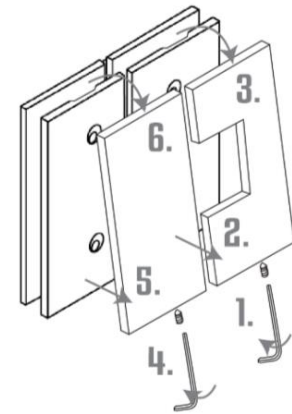

DOOR REALIGNMENT

Use 3mm key on the cap screws near the pivot to loosen the screws, align the door to desired position and then tighten.

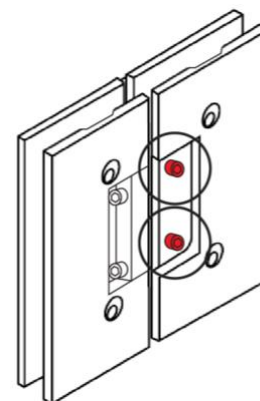

16. DOOR INSTALLATION

Hinges should be in the closed position (in line) before attempting to install the glass door.

17. HANDLE INSTALLATION

Assemble the handles as shown.

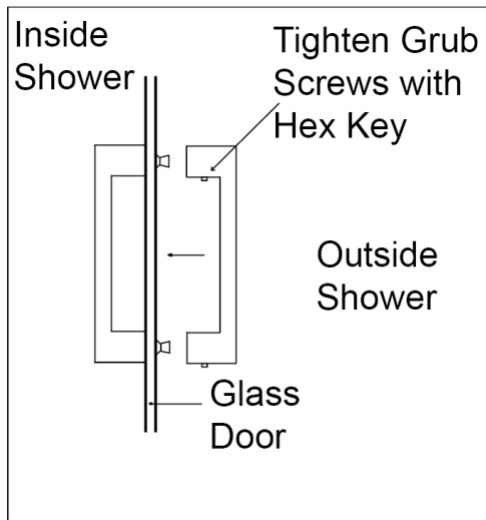

18. DOOR CLEARANCE

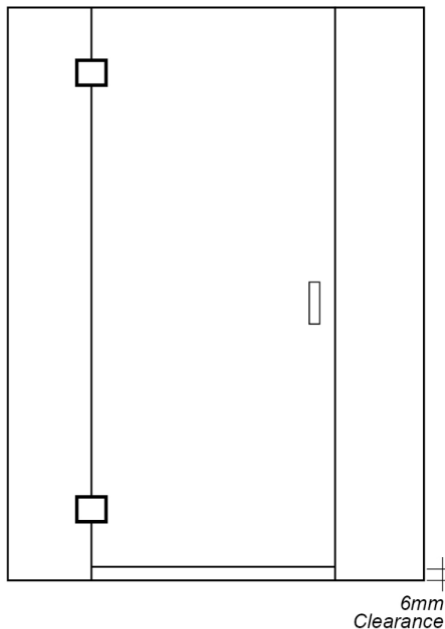

This is the general layout of the correctly aligned screens.

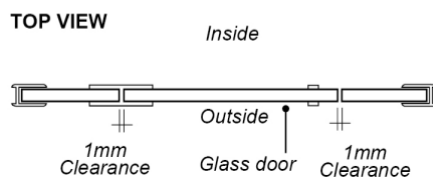

19. TOP BRACE PREPARATION

Place the two side blocks on top of the fixed glass panels (within 10mm of the inside edges).

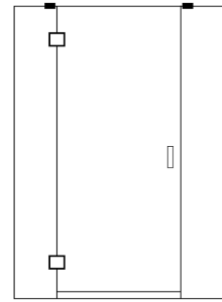

20. TOP BRACE ASSEMBLY AND INSTALLATION

(Not required for 900 or 1000 wide showers)

Place the Top Brace onto the fixed glass panels as shown. Mark on the Top Brace where the loose side blocks are to be located. Remove the Brace. Drill and fix the side blocks to the Top Brace with the screws provided. Place the completed Top Brace onto the fixed glass panels. Lightly tighten the grub screws onto the glass panels.

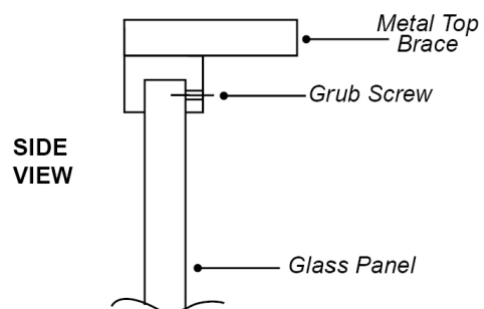
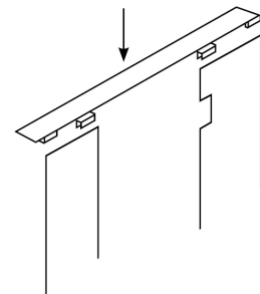

21. SILICON APPLICATION

Using the blue tape supplied, mask the glazing channel and glass at the intersections as shown. Apply clear silicon to the inside and outside of the base and wall receiver channels. Remove the excess silicon. Remove the masking tape immediately after application.

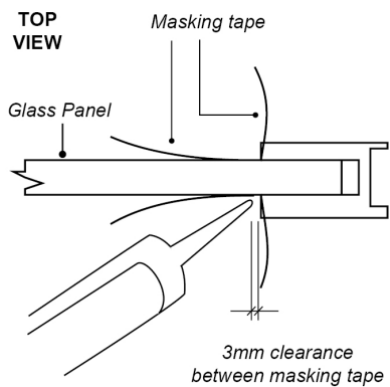

22. INSTALLATION OF BOTTOM DOOR SEAL

Trim to length if necessary. Clip onto the bottom of the door. Ensure the sloping face is inside the shower.

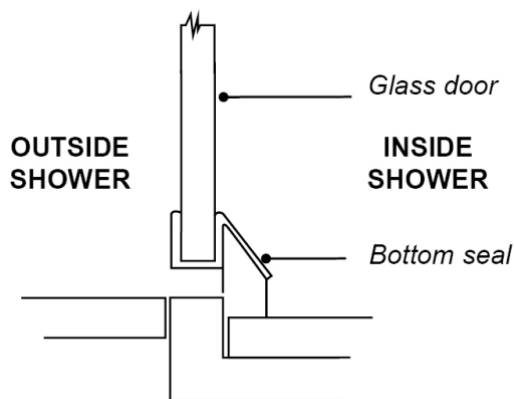

OPTIONAL DOOR SEALS

Two vertical edge seals are supplied with the wall glazing channels. These may be applied to the door opening edges (seals are usually applied to the fixed panels). Seals for the hinged side require being trimmed to fit between the hinges.

Should these seals be required, it is recommended to install them while installing the glass and hinges.

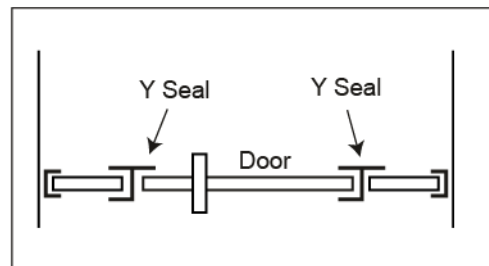

2 Wall – Angle Front

1. Choose door direction

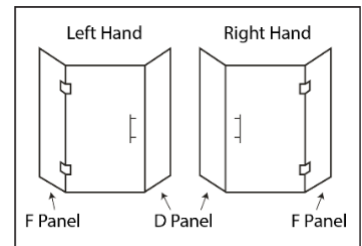

2. Position wall channel over base channel. Mark wall to indicate where wall channel is plumb.

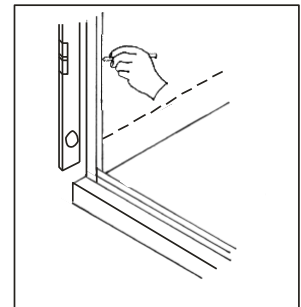

3. Ensure the glass receiver channels are located firmly over the base glazing channels.

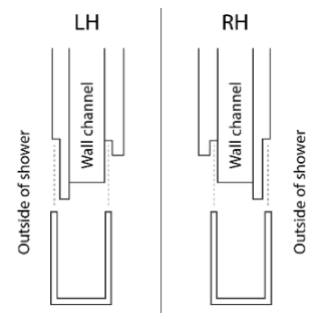

4. Apply a silicon seal to full length of channel. Silicon used must be compatible with anodised aluminium as well as the waterproofing used.

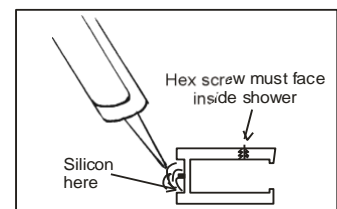

5. Locate framing timber. Use 4mm drill bit to drill holes through wall channels. Fix four screws into each channel (use wall plugs if required).

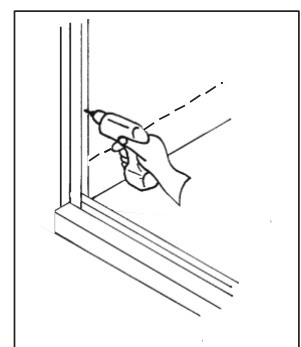

- Apply a 10mm continuous bead of Flexicone, to the full length of each wall channel. Silicon seal the join where the wall and base channel will intersect. Screw the wall channels to the wall (ensuring they are plumb).

Acrylic Liner (Fig.1) - apply an additional bead of silicon to the outside of the acrylic liner.

Tiled Walls (Fig.2) – apply an additional bead of silicon to the inside of the waterproofing

Fig.1 -Acrylic Liner
– Silicon seal outside wall channel

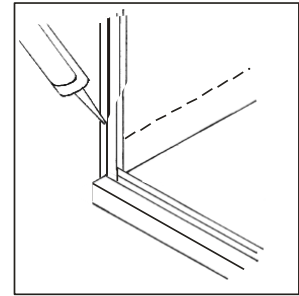
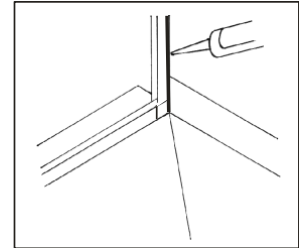
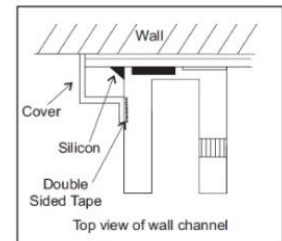

Fig.2 - Tiled Walls
–Silicon seal inside wall channel



This step only applies if acrylic wall liner has been supplied.

- Fix liner cover to wall channel covering exposed liner edge as shown.



- Keep glass standing upright. Once package containing glass is opened, check glass is facing same direction up as label, do not sit glass directly on floor, always sit glass on polystyrene packaging or similar padded surface. Keep glass level with floor to avoid hitting corners on hard surfaces.

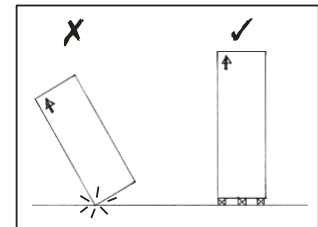

No responsibility will be taken by Atlantis for any glass breakages through installers actions causing breakage.

- The sill infill will be taped into the base glazing channel. This infill must measure 3mm larger than the door, trim if necessary. Slide this sill infill firmly to panel **D** side of bottom channel. Tape in position.



Protect all channels from adhesive and grouts by covering with masking tape.

- Start by placing plastic packers into bottom channels in locations as shown. Add or remove other packers if required.

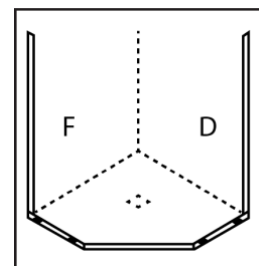

- 11. Critical Seal.** Remove the dust and dirt first. Seal the connection between the glass receiver channel and the base glazing channel with clear silicon, prior to final glass placement. Ensure junction between wall channel and base channel is full of silicon before final glass placement.

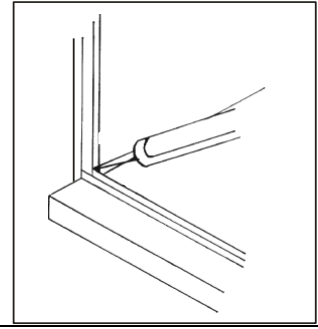

The following steps for installing glass must be followed to ensure a professional result.

12. Locate panel **D** into channels firmly against sill infill. Adjust height of panel if necessary by adding or removing packers in bottom channel. Ensure panels are flush to top of channel and plumb.

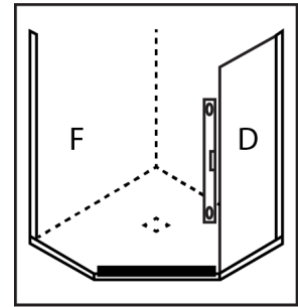

13. Locate panel **F** into channels and slide firmly to sill infill. Adjust this panel ensuring it is level and plumb to panel **D** by adding or removing packers in bottom channels.

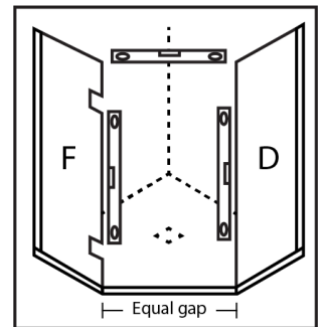

14. Fixing of glass panels into wall channels

Fix glass into channels by tightening hex screws firmly with hex keys supplied. Ensure glass return panels line up with each other when viewed in the direction as shown by arrows.

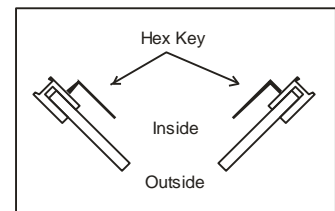

15. Assemble handles as shown. Fit handles to glass door prior to installing door in position. Fix ferrule screws through glass. **Do not over tighten.** Locate second handle over ferrules. Tighten two grub screws with small hex key supplied.

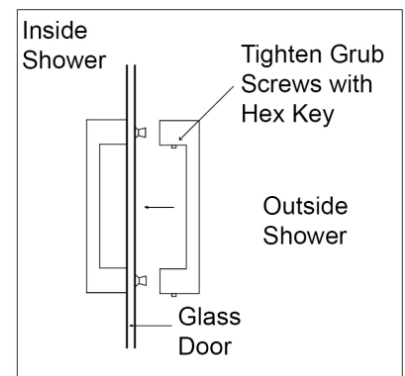

16. Place 6mm packers over sill before installation of glass door to allow correct clearance for door.

Apply 1mm plastic packer to edge of glass with masking tape as shown. Position one next to each hinge cut out (this will ensure correct door clearance and prevent glass damage).

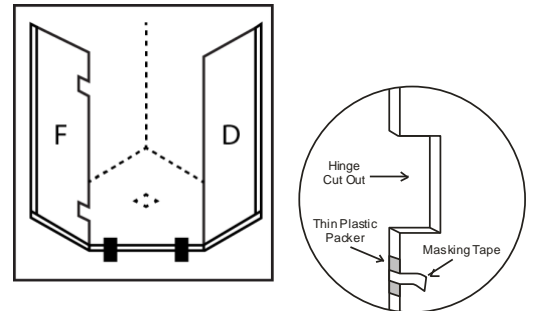

Hinge Installation. Atlantis glass (*EXCLUDING 1930MM HIGH GLASS*) is now coated with CristalCote glass protection in the factory. This coating may cause the hinge to slip after installation. Atlantis recommends cleaning around the hinge cut out prior to fitting hinges. Clean both sides of the glass 15mm around the edge of the cut out with Fuelite (fuellite is available from petrol stations). Alternatively, the area can be lightly sanded with 300grit sandpaper.

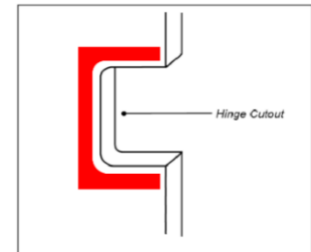

17. **Adjustable Hinges – Atlantis showers are now supplied with adjustable hinges**

COVER PLATE REMOVAL

Remove the cover plate by loosening the small grub screws on the edge of the hinge cover using a 1.5mm hex key. Loosen the bolts with 4mm hex key

Fit the hinges. The removable cover (and bolts) must be on the outside of the shower.

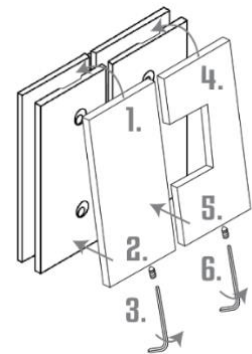

18. **Door Installation**

Hinges should be in the closed position (in line) before attempt in to install the glass door.

Slide the door into the hinges. Centre the door between the side panels and tighten the hinge bolts firmly with the 4mm hex key supplied.

ENSURE HINGES ARE CLEAR FROM SIDES OF GLASS CUTOUTS AND HINGE BOLTS ARE FINALLY TIGHTENED AS MUCH AS POSSIBLE.

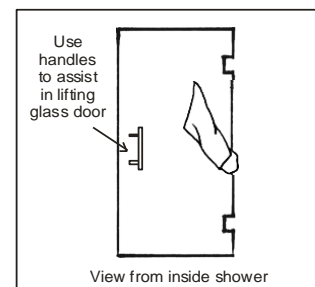

REFIT COVER PLATE

Place the cover plate over the hinge body as shown. Refit cover plate with a 1.5mm hex key

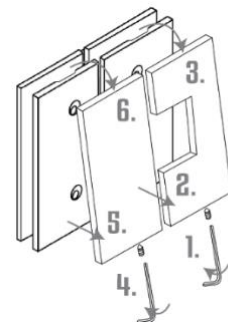

19. DOOR REALIGNMENT

If required, use 3mm hex key to loosen the cap screws near the, align the door to desired position and then re-tighten.

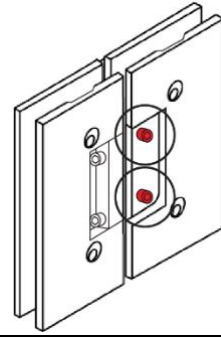

20. Door clearances

Minimum clearance of 3mm under door. See **Step 24** for information about the bottom door seal.

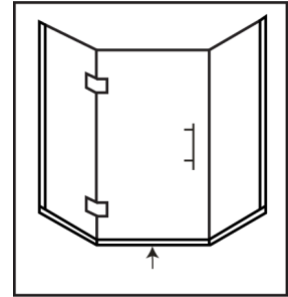

21. This is the general layout of the complete door.

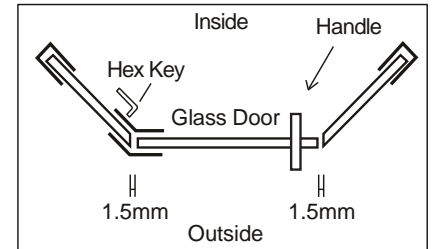

22. Drill and screw the blocks onto the top brace, as per the positioning guide supplied. Place the brace onto the screens and tighten the top brace grub screws to secure the brace. Do not over tighten grub screws onto the glass.

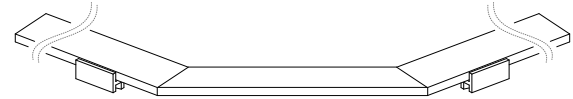

23. Mask channels and glass in position as shown. Apply clear silicon to inside and outside of glass panels. Use spatula to remove excess.

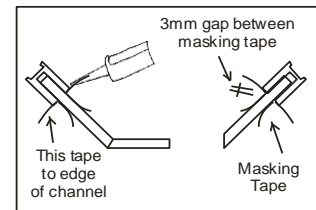

24. **Door Opening Sill Infill** – Apply a continuous bead of clear silicon to each inside face of the base channel. Ensure the ends of the infill are sealed and place into the base channel as shown.

Installation of bottom door seal. Trim to length if necessary. Clip onto the bottom of the door. Ensure the sloping face is inside the shower.

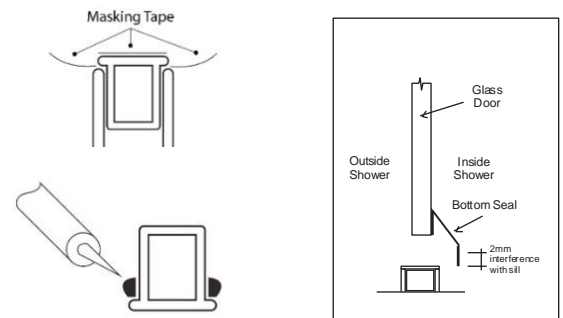

25. **Door Seal Installation** – If required, please install seals as shown. If fitted, the **Y SEAL** will need to be trimmed to length to fit around the hinges.

